

 newbits

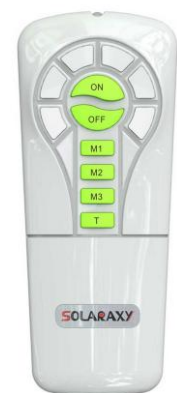

TUCANO 2

LAMPĂ SOLARĂ DE PERETE



# INTRODUCERE

Specificațiile produsului

01 INTRODUCERE

02 CATALOG

03 AVANTAJE PRINCIPALE

04 ALTE AVANTAJE

05 SPECIFICAȚII

06 DIAGRAMA OPTICA

07 DIMENSIUNI

08 MAI MULTE DETALII

09 TEHNOLOGIE NUCLEU

10 DETALII PACHET

11 UTILIZARE

## AVANTAJELE PRODUSULUI

Tehnologia ASL garanteaza 10 nopti de functionare continua  
Tehnologia TCS asigura o durata de viata mare a bateriei

**2000LM**

**MAI LUMINOASE SI MAI DURABILE**

Furnizeaza cea mai profesionala lumina solara de gradina pentru fiecare familie



**SILVER**



**SILVER-GREY**



**BLACK**





Telecomanda pentru  
diferite moduri de iluminare

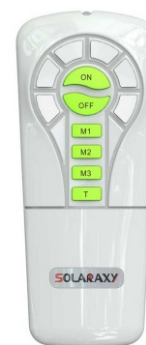

Φ115MM

PIR: Lentile opace Fresnel  
anti-interferente  
Indicator baterie

● 10%—50%

● 50%—80%

● 80%+



Articol: SWL-06 PRO

Putere 20W

## Panou solar

Putere

Policristalin, 2W

## Baterie Li-ion

Capacitate

3.7V19.24WH 2.6AH/BUC

Temp. de încărcare/descărcare

0~45°C/-20~60°C

Timp de incarcare

13H

LED (OSRAM)

2835 40 buc

Temp. culoare

3000KR<sub>a</sub> 80+

Eficienta

190lm/W

LED UV

-

## Performanta

Timp de iluminare în zilele ploioase

&gt; 10 zile

Modul de control

Buton comutator, ON/OFF Apăsare lungă 1,5 secunde

Modul de iluminare (comandă de la distanță)

M1: 60LM+PIR 2000LM(10S)  
 M2: 120LM+PIR 2000LM(10S)  
 M3: 200LM(5H)+40LM(7H) / PIR 2000LM(10S)  
 T: Apăsarea scurtă o dată va sincroniza 100% luminozitate timp de 10 minute, scurt apăsăți de 2 ori timp de 20 de minute de 100% luminozitate, când sincronizarea se termină, lumina va reveni la modul de iluminare anterior

Indicarea modului

-

Indicație de capacitate

-

PIR

120 ° &gt;5m

Tehnologia de bază

ALS 2.1 / TCS 1.0

Autocurățare panouri solare

-

Clasa IP/IK

IP65 / IK10

Înălțime de instalare

2,5 M-3,5 M



Diagrama simulată a drumului

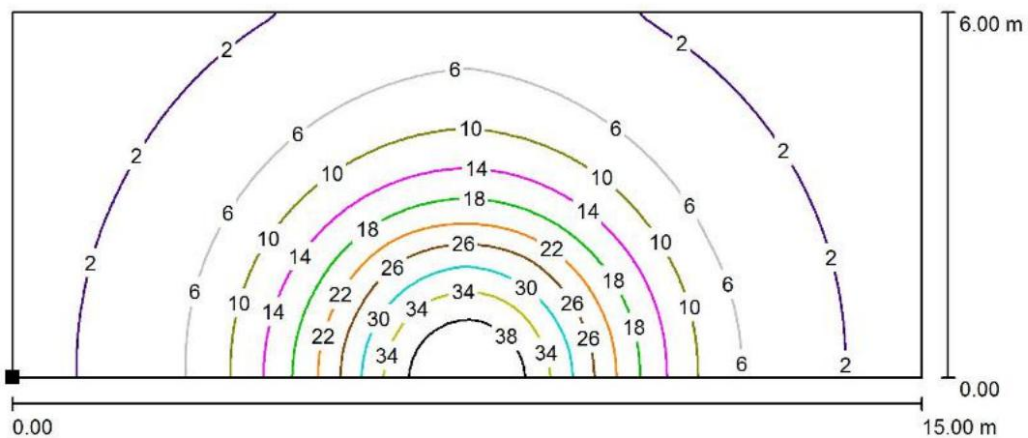

Curba de iluminare

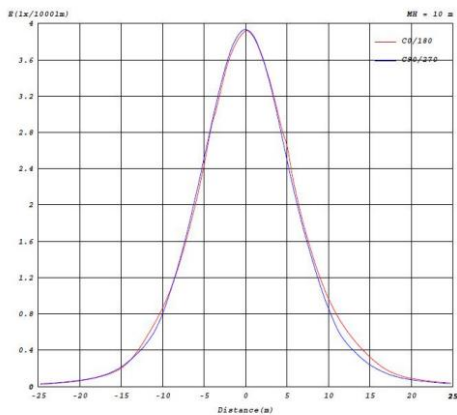

Distribuția Luminanței

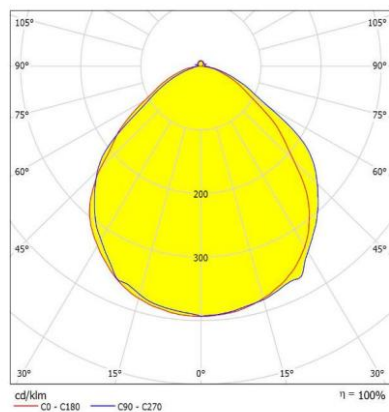

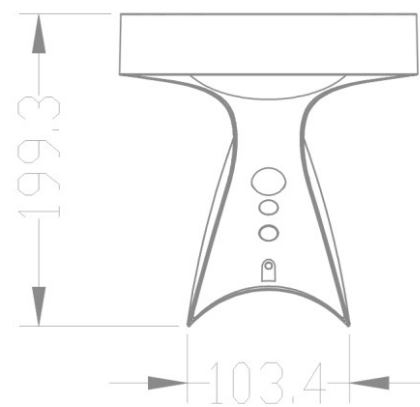
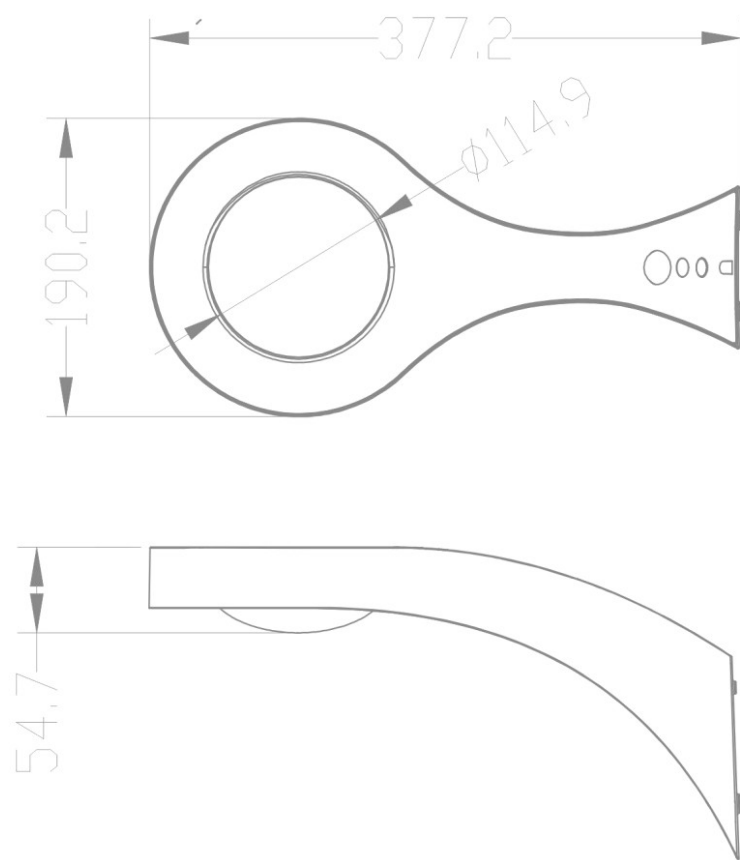



## BENEFICII

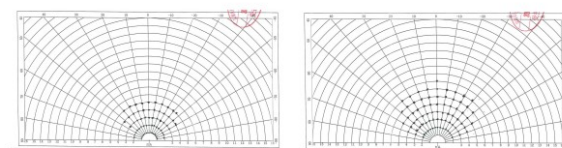

Test de inductie PIR

Telecomanda cu infrarosu  
test de detectare



LED-uri cu lumen mare 190lm/W  
Abajur larg - 115mm

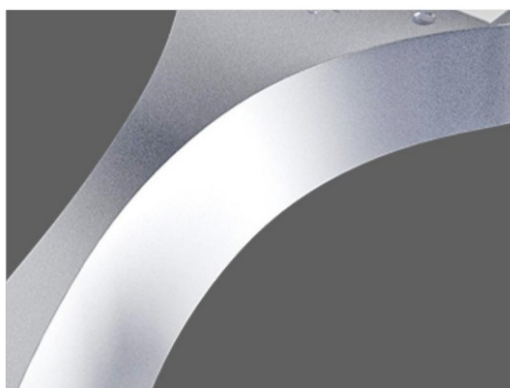

Proiectare din aliaj



PIR : >5m, 120°  
Lentile opace Fresnel anti interferente

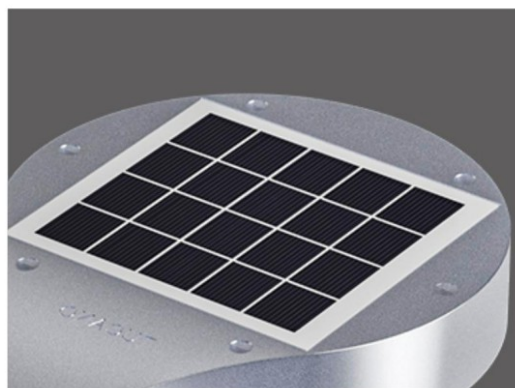

Policristalina  
Eficienta de încarcare solara:> 19%



Receptor IR  
Comutator de alimentare cu LED indicator



Detalii spate



O companie mare ar trebui sa acorde intotdeauna o atentie ridicata la designul fiecarui detaliu, iar spiritul de maiestrie, ar trebui completat in procesul de proiectare si productie in masa.



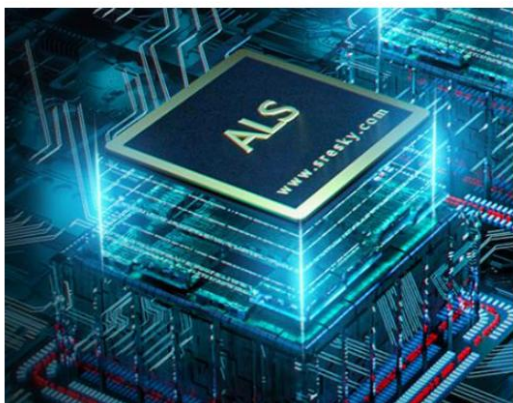

AVANTAJUL ASL

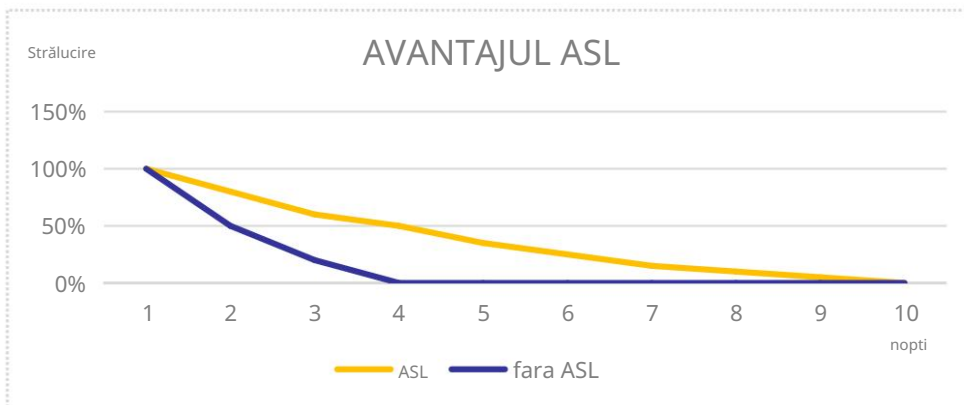

AVANTAJUL TCS

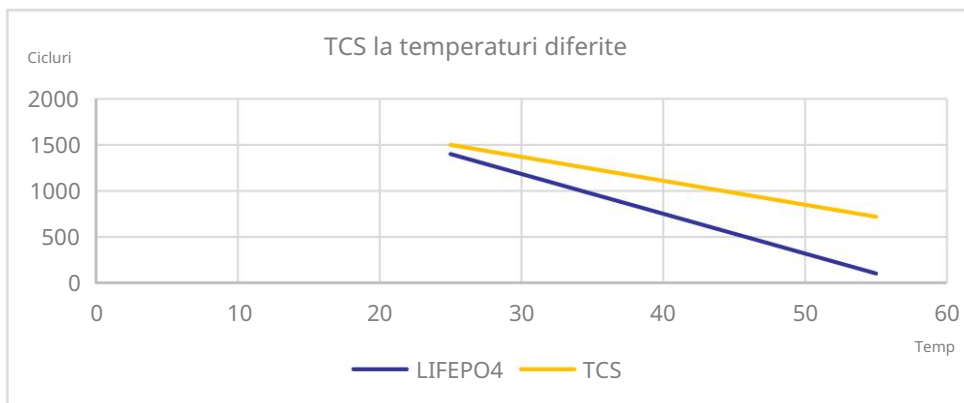

## LISTA DE PRODUSE

Șurub: 2 buc  
 Șuruburi cu expansiune: 2 buc  
 TELECOMANDA: 1 PC



CUTIE INTERIOARĂ  
 DIMENSIUNE: 45,5\*16,2\*23,8 cm  
 1 BUC / 1 CUTIE



1 STRAT  
 1 STRAT = 4 CUTII

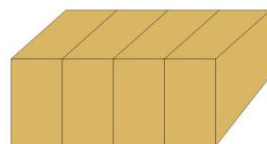

MASTER CARTON  
 DIMENSIUNE: 66,0\*47,0\*25,7cm  
 4 CUTII / CTN

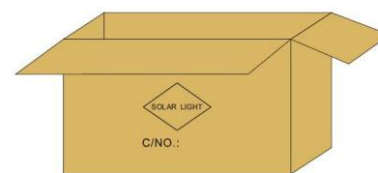

NUMĂRUL STRATULUI

CUTIE DE CARTON

CUTIE COLOR

LISTA DE PRODUSE

PASUL 1

PASUL 2

PASUL 3

PASUL 4

NUMARUL MODELULUI	METODĂ AMBALARE	PCS/CTN	CANTITATE (BUC)	CTN CANTITATE	DIMENSIUNE CUTIE (CM)	NW (KG)	GW (KG)
SWL-06 PRO	CUTIE INTERIOARĂ	1	1	1	45,5*16,2*23,8	1.02	1,37
	CUTIE DE CARTON	4	4	1	66,0*47,0*25,7	4	6.5

Greutatea netă și greutatea brută sunt doar pentru referință



S / O / L / A / R / L / I / G / H / T

VA MULTUMIM!

CONTACT: Email: [info@newbits.ro](mailto:info@newbits.ro)